

We are IntechOpen, the world's leading publisher of Open Access books Built by scientists, for scientists

6,300

Open access books available

172,000

International authors and editors

190M

Downloads

Our authors are among the

154

Countries delivered to

TOP 1%

most cited scientists

12.2%

Contributors from top 500 universities



WEB OF SCIENCE™

Selection of our books indexed in the Book Citation Index
in Web of Science™ Core Collection (BKCI)

Interested in publishing with us?
Contact book.department@intechopen.com

Numbers displayed above are based on latest data collected.
For more information visit www.intechopen.com



Fuzzy Detection of Fetal Distress for Antenatal Monitoring in Pregnancy with Fetal Growth Restriction and Normal

Igor V. Lakhno,
Bertha Patricia Guzmán-Velázquez and
José Alejandro Díaz-Méndez

Additional information is available at the end of the chapter

<http://dx.doi.org/10.5772/intechopen.80223>

Abstract

Monitoring of fetal cardiac activity is a well-known approach to the assessment of fetal health. The fetal heart rate can be measured using conventional cardiotocography (CTG). However, this method does not provide the beat-to-beat variability of the fetal heart rate because of the averaging nature of the autocorrelation function that is used to estimate the heart rate from a set of heart beats enclosed in the autocorrelation function window. Therefore, CTG presents important limitations for fetal arrhythmia diagnosis. CTG has a high rate of false positives and poor inter- and intra-observer reliability, such that fetal status and the perinatal outcome cannot be predicted reliably. Non-invasive fetal electrocardiography (NI-FECG) is a promising low-cost and non-invasive continuous fetal monitoring alternative. However, there is little that has been published to date on the clinical usability of NI-FECG. The chapter will include data on the accurate diagnosing of fetal distress based on heart rate variability (HRV). A fuzzy logic inference system was designed based on a set of fetal descriptors selected from the HRV responses, as evident descriptors of fetal well-being, to increase the sensitivity and specificity of detection. This approach is found to be rather prospective for the subsequent clinical implementation.

Keywords: fetal non-invasive electrocardiography, fetal heart rate variability, fetal distress

1. Introduction

Electronic fetal monitoring is an important part of the prenatal surveillance system that contributes to the best perinatal outcome. Its objective is the correct evaluation of fetal well-being.

However, the lack of precision of several methods that monitor the fetal well-being is well known [1].

Cardiotocography (CTG) methods have been standard, despite the lack of evidence that it reduces the adverse sequelae of neurodevelopment, including neonatal hypoxic-ischemic encephalopathy and cerebral palsy. This method has a high rate of false positives, and poor inter- and intraobserver reliability [2–4], such that fetal status and the perinatal outcome cannot be predicted reliably.

CTG is a widely available method for fetal development research, based on cardiac rhythm reactivity to fetal intrauterine motor activity in the prenatal period. Doppler ultrasound is the most obvious technological approach for monitoring fetal well-being. However CTG-based techniques require prolonged ultrasonic monitoring.

CTG demonstrates the response of the sinus node to the continuous interaction of the sympathetic and parasympathetic tones of the autonomic nervous system [5, 6]. Autonomic control of fetal cardiac rhythm could be investigated by fetal heart rate variability (HRV). HRV captures the impact of central and peripheral circuits on regulation in hemodynamics [7]. The recording of primary bioelectrical processes in the sinus node can be assumed to be a more valuable technique than the mechanical detection of cardiac cycles used in CTG [1].

The fetal HRV parameters exhibit a wide range, even under normal conditions. The peculiarities of the fetal neurobehavioral response in the active and sleepy periods may complicate the interpretation of the conventional CTG tracing, and increase the level of cesarean interventions [8–10].

Recent research has explored different biochemical and biophysical markers, as well as the correlation between maternal-fetal hemodynamic processes, to better understand the complex processes involved in the loss of fetal well-being [11–20].

The objective of this study is the design of a fuzzy inference system based on a set of fetal descriptors, selected from the CTG and HRV responses, as evident markers of fetal well-being, to increase the sensitivity and specificity in evaluation of fetal distress.

2. Analysis and selection of descriptors

For the development of this study, records of 49 pregnant women were used. These were taken in the Department of Maternal and Fetal Medicine of Kharkiv municipal perinatal center. These records were divided into four groups: Group I composed of healthy pregnant women without loss of fetal well-being, group II of healthy pregnant women with loss of fetal well-being, group III of pregnant women of high-risk type III without loss of fetal well-being, and group IV of pregnant women of high-risk type III with loss of fetal well-being. NI-FECG tracing was obtained from the maternal abdominal wall using the Cardiolab Babycard equipment

(Scientific and research center “KhAI Medica,” Ukraine) [1, 11, 12]. The sampling rate was 1000 Hz. For all reported cases, the study protocol was approved by the Bioethics Committee of the Kharkiv Medical Academy of Postgraduate Education (registration number 0105 U002865). For training purposes of fuzzy inference system, the 49 records were divided into windows of 2 minutes to obtain 296 datasets of HRV and CTG parameters.

In order to select the best descriptors to design the fetal well-being inference system, an observation was made using ROC curves and Spearman correlation of the different fetal HRV and CTG parameters used in [12] and shown as the best correlated with Apgar Score 1. These parameters are shown in **Table 1**.

The specificity (S_p) and the sensitivity (S_e) of the parameters concerning the fetal well-being were obtained from the ROC analysis. S_p and S_e are given by Eqs. (1) and (2), respectively:

$$S_p = \frac{VN}{VN + FP} \tag{1}$$

where VN are the true negatives and FP are the false positives.

Index	Definition
HRV parameters	
SDNN	Standard deviation of normal to normal intervals
RMSSD	Root mean square of successive heart beat interval differences
PNN50	Proportion of the number of pairs of NNs differing by more than 50 ms divided by the total number of NNs
AMO	Mode amplitude (the most frequent value of NN interval of the highest column in the histogram)
SI	Stress index
TP	Total power
VLF	Very low frequency
LF	Low frequency
HF	High frequency
CTG parameters	
STV	Short-term variability
LTV	Long-term variability
ACC	Accelerations
DES	Des-accelerations
LOWVAR	Low variability
HIGVAR	High variability

Table 1. HRV and CTG parameters.

$$S_e = \frac{VP}{VP + FN} \quad (2)$$

where VP are the true positives and FN corresponds to the false negatives.

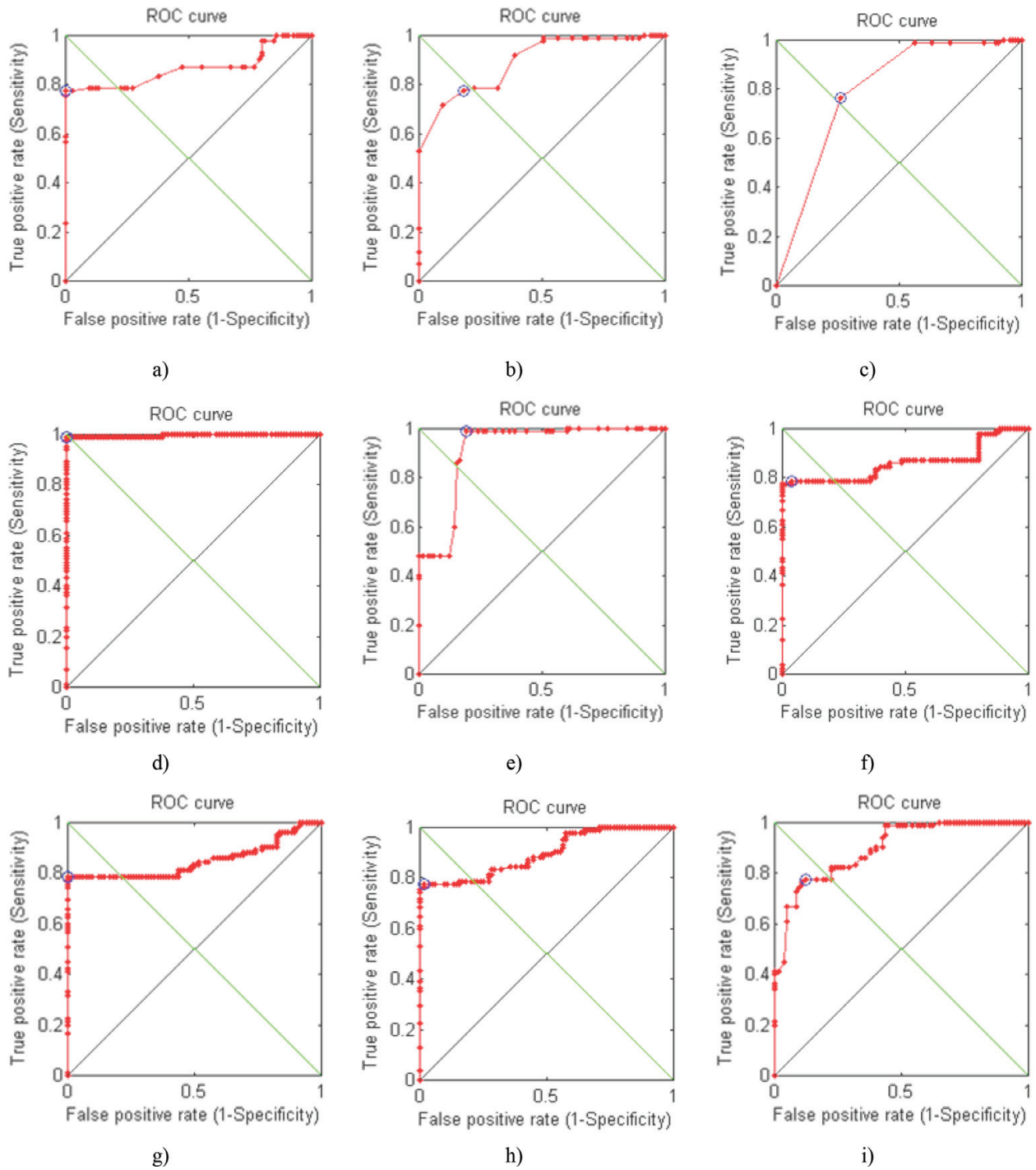

Figure 1. ROC curves for HRV variables. (a) SDNN AUC = 0.8653, (b) RMSSD AUC = 0.8922, (c) pNN50 AUC = 0.7982, (d) SI AUC = 0.9956, (e) AMo AUC = 0.917, (f) TP AUC = 0.8614, (g) VLF AUC = 0.8514, (h) LF AUC = 0.898, and (i) HF AUC = 0.8976.

Spearman’s correlation (ρ) between bio-signal parameters and well-being fetus state is given by:

$$rs = 1 - \frac{6 \sum_{i=1}^n d_i^2}{n(n^2 - 1)} \quad (3)$$

where d_i is the ranges of values for i -parameter and the clinical diagnosis.

Figures 1 and 2 show the ROC curves for the HRV and CTG fetal parameters. As can be seen, the highest AUC is obtained for AMo = 0.9170 and SI = 0.9956 for HRV and, ACC = 0.9974, LTV = 0.9950, STV = 0.9972 and LOWVAR = 0.9922 for CTG. The smallest area was obtained for PNN50 = 0.7982 and DES = 0.6071 for HRV and CTG, respectively.

Table 2 shows the results of the sensitivity, specificity, and Spearman’s correlation for HRV parameters which are also shown in Figure 3. SDNN, which measures the general variability of the neurovegetative system, showed a high Sp = 1 and a Spearman’s correlation of -0.6352,

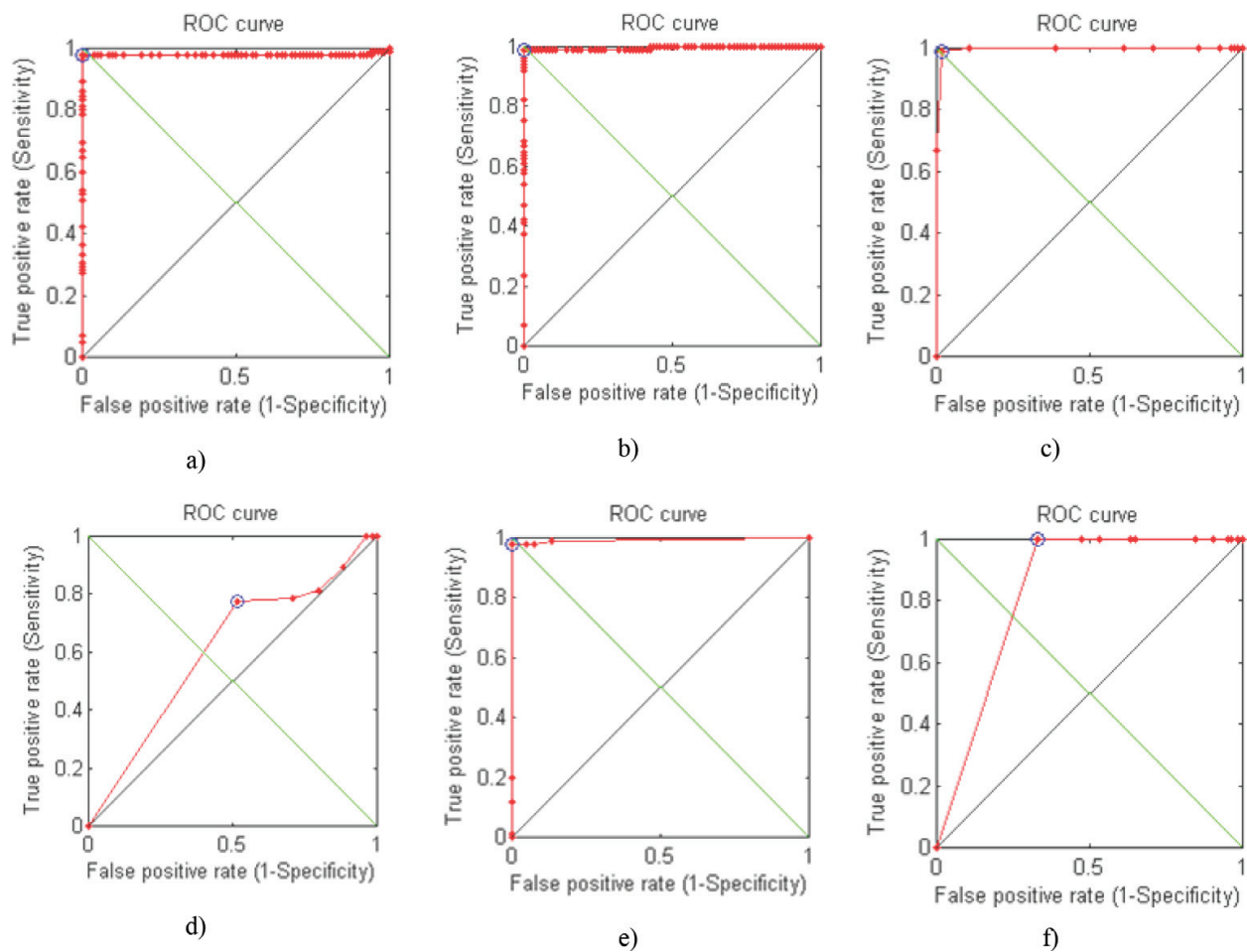

Figure 2. ROC curves for CTG parameters: (a) STV = 0.9772, (b) LTV = 0.9950, (c) ACC = 0.9974, (d) DES = 0.6071, (e) LowVar = 0.9922, and (f) HighVar = 0.8353.

Descriptor	AUC	Sensitivity	Specificity	ρ -Spearman
SDNN	0.8653	0.7765	1	-0.6352
RMSSD	0.8922	0.7765	0.8235	-0.6826
PNN50	0.7982	0.7647	0.7412	-0.5612
SI	0.9956	0.9882	1	0.8585
AMo	0.9170	0.9882	0.8112	0.7243
TP	0.8614	0.7882	0.9647	-0.6262
VLF	0.8514	0.7882	1	-0.6089
LF	0.8980	0.7765	0.9882	-0.6895
HF	0.8976	0.7765	0.8824	-0.6894

Table 2. AUC, sensitivity, specificity, and Spearman's correlation of fetal HRV parameters.

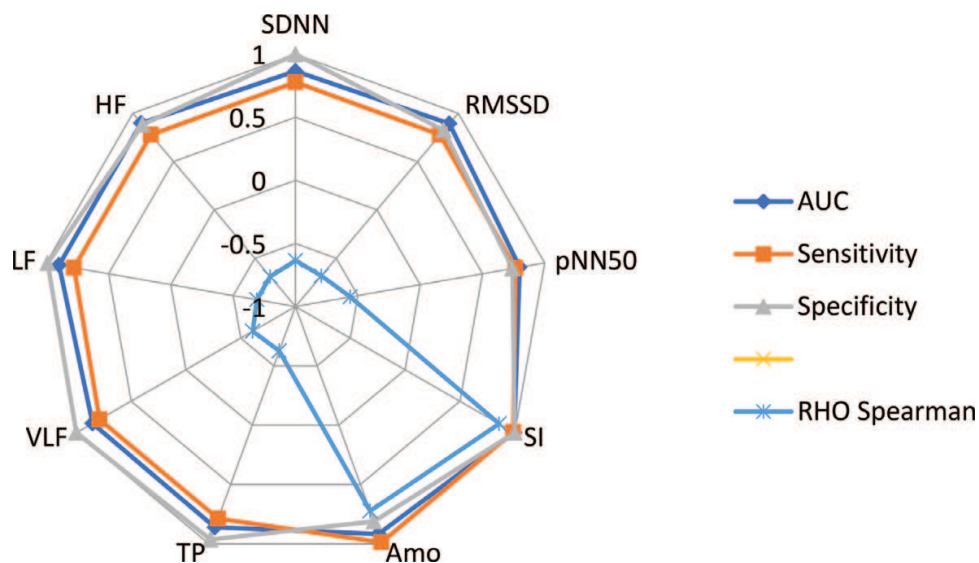

Figure 3. AUC, sensitivity, specificity, and Spearman's correlation of HRV parameters in the study population.

however showed a low value of $Se = 0.7765$. RMSSD, which is related to high-frequency components, like HF are below 0.90 in the values of both $Se = 0.7765$ and $Sp = 0.8235$. TP and LF, although they have a high specificity, 0.9647 and 0.9882 respectively, have a low sensitivity of 0.7882 and 0.7765, respectively. VLF although it has a high specificity $Sp = 1$ and a Spearman's correlation of -0.6089 , its sensitivity is low, $Se = 0.7882$; HF also presents a low sensitivity of 0.7765. Pnn50 had the lowest sensitivity and specificity $Se = 0.7765$ and $Sp = 0.7412$. SI presented $Se = 0.9882$ and $Sp = 1$; and AMo showed $Se = 0.9882$ and $Sp = 0.8112$. The Spearman's correlation for SI and AMo are, respectively, 0.8585 and 0.7243, which is consistent since SI and AMo are independent of the steady state of the fetus and can be considered evident markers of fetal well-being [12].

In the same way in **Table 3** are shown AUC, Se , Sp , and ρ for CTG parameters, these are shown also in **Figure 4**. As can be seen, the highest values were obtained for: STV with a $Se = 0.9765$, $Sp = 1$, and ρ -Spearman = -0.8271 . LTV with a $Se = 0.9882$, $Sp = 1$, and ρ -Spearman = -0.8579 .

Parameter	AUC	Sensitivity	Specificity	ρ -Spearman
STV	0.9772	0.9765	1	-0.8271
LTV	0.9950	0.9882	1	-0.8579
ACC	0.9974	0.9882	0.9882	-0.8826
DES	0.6071	0.7765	0.4824	-0.2176
LOWVAR	0.9922	0.9765	1	0.9218
HIGVAR	0.8353	1	0.6706	-0.6918

Table 3. AUC, sensitivity, specificity, and spearman’s correlation of fetal CTG parameters.

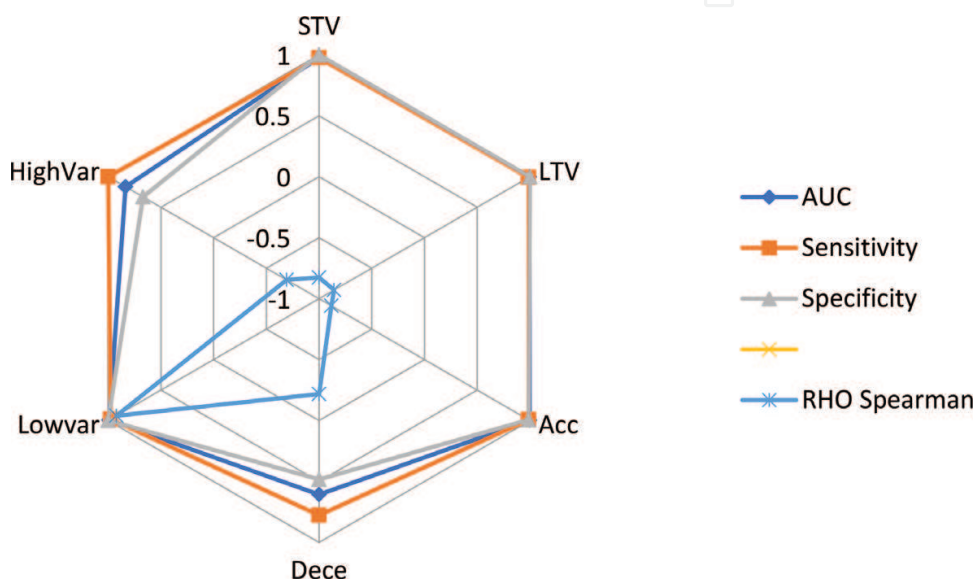

Figure 4. AUC, sensitivity, specificity, and Spearman’s correlation of CTG parameters in the study population.

The accelerations (ACC) with $Se = 0.9882$, $Sp = 0.9882$, and ρ -Spearman = -0.8826 . LOWVAR with a $Se = 0.9765$, $Sp = 1$, and ρ -Spearman = 0.9218 . Although HIGHVAR shows a high $Se = 1$, its Sp is low of 0.6706 . The evaluation of short-term variations (STV) and long-term variations (LTV) allow that can be used as markers of fetal compromise.

3. Fuzzy inference system design

The inference system of the fetal well-being state was designed with fuzzy logic, Mamdani-type, 4 inputs (SI, AMo, STV, and LTV), 1 output (status of fetal well-being), and 16 fuzzy rules. The block diagram is shown in **Figure 5**. The fuzzy logic design allows us to take advantage of the linguistic interpretation capacity in complex problems, when there is no simple solution model or a precise mathematical model, such as the detection of loss of fetal well-being. The ranges of selected descriptors are shown in **Table 4**, and were used as the basis for the design of the fuzzy membership functions.

The input variables for fuzzy inference system are SI and AMo for HRV and STV and LTV for CTG. **Figure 6** shows the input membership functions for these variables.

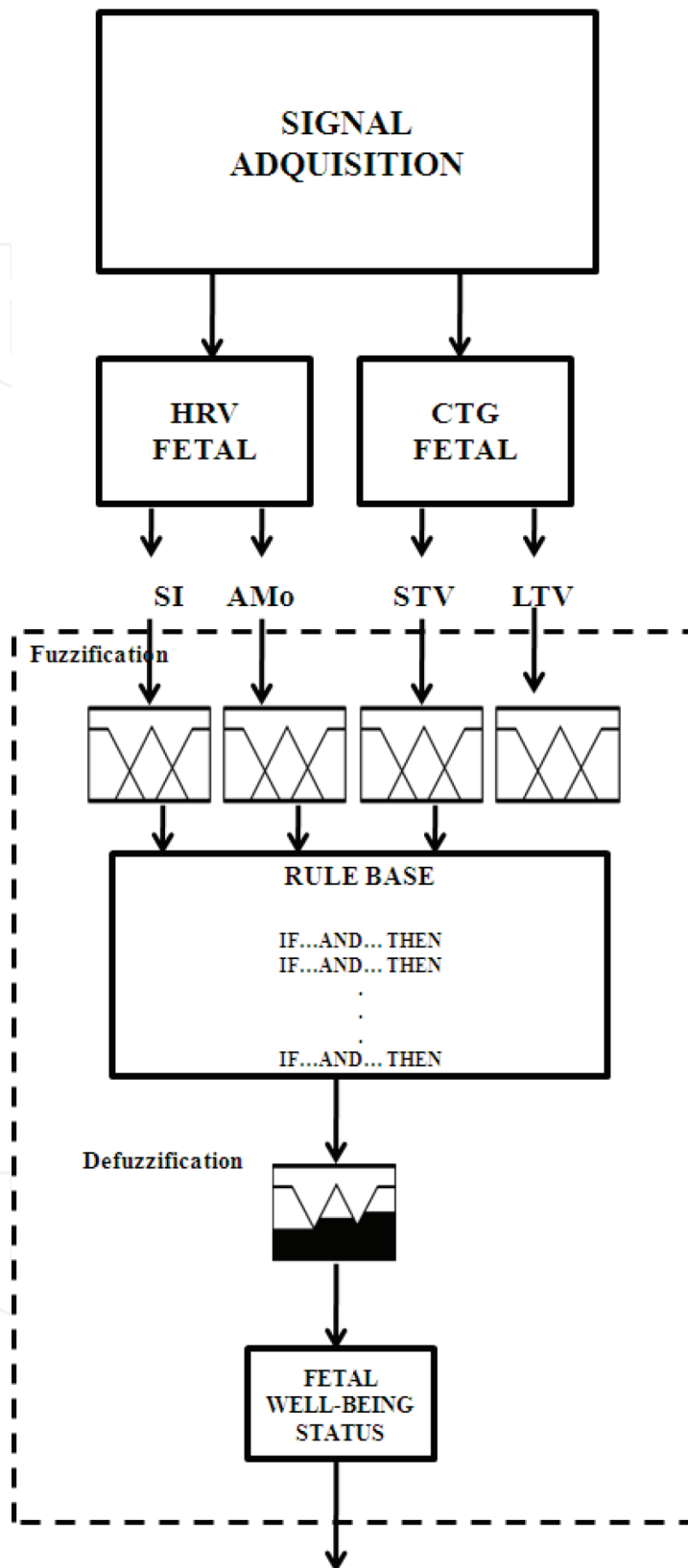

Figure 5. Fuzzy inference system for loss of fetal well-being detection.

Descriptor	Normal	Distress
SI, C.U.	75–2000	1246–3040
AMo, %	29–99	69–100
LTV, MS	26.6–165	14–27.5
STV, MS	5.3–40.4	2.5–6.1

Table 4. Ranges of values of the fetal status descriptors.

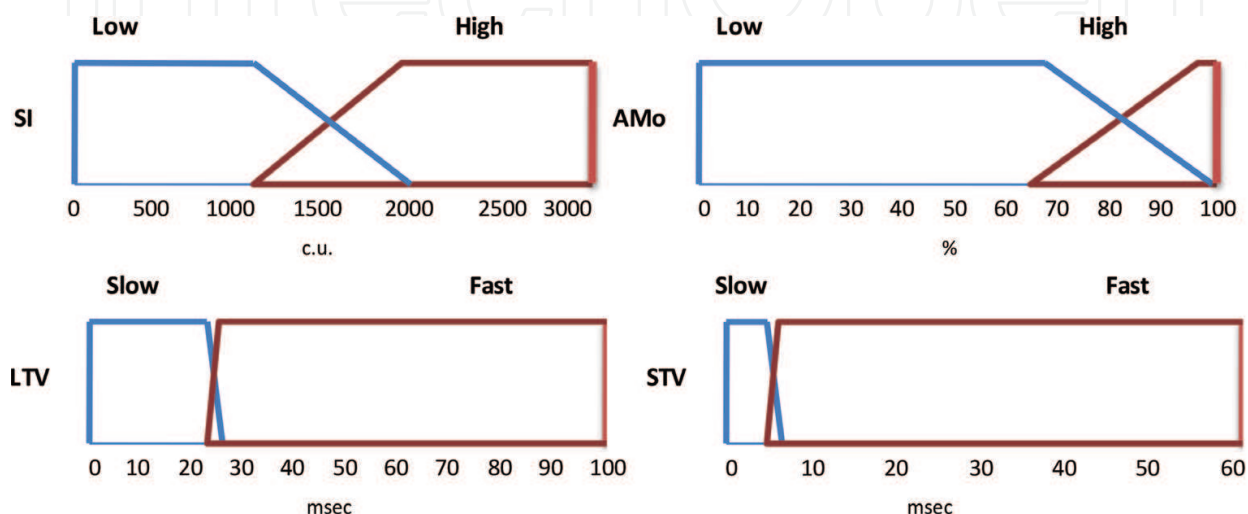

Figure 6. Membership functions for input descriptors: (a) SI, (b) AMo, (c) LTV, and (d) STV.

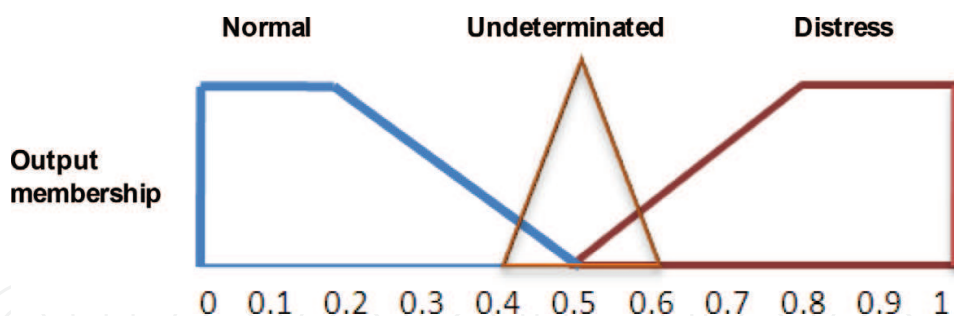

Figure 7. Membership functions for fuzzy system output sets.

The fuzzy output is shown in **Figure 7**, and this is defined by two trapezoidal membership functions, representing normal (N) or distress (D) fetal status, and by a triangular function in which the diagnosis is indeterminate by fuzzy system. The “Normal” output is in the range from 0 to 0.4; for the output “Distress,” the rank is of 0.6 to 1.0; and if the output is between 0.4 and 0.6, it is classified as “indeterminate.”

The fuzzy knowledge base is shown in **Table 5**. In order to increase the presumption of fetal well-being detection, the inference would have to be “Normal,” if and only if, the membership

	SI	AMO	LTV	STV	DX
1	Low	Low	Fast	Fast	Normal
2	Low	Low	Fast	Slow	Undetermined
3	Low	Low	Slow	Fast	Undetermined
4	Low	Low	Slow	Slow	Undetermined
5	Low	High	Fast	Fast	Undetermined
6	Low	High	Fast	Slow	Distress
7	Low	High	Slow	Fast	Distress
8	Low	High	Slow	Slow	Distress
9	High	Low	Fast	Fast	Undetermined
10	High	Low	Fast	Slow	Distress
11	High	Low	Slow	Fast	Distress
12	High	Low	Slow	Slow	Distress
13	High	High	Fast	Fast	Undetermined
14	High	High	Fast	Slow	Distress
15	High	High	Slow	Fast	Distress
16	High	High	Slow	Slow	Distress

Table 5. Fuzzy knowledge base for well-being fetal status.

of the fuzzy sets in the four input descriptors belongs to “Normal” set. On the other hand, the output will be “distress” if the membership in at least one variable of HRV and CTG belong to the input set related to fetal distress. Fuzzy inference can be indeterminate if membership of fuzzy sets in three inputs belongs to sets related to normal fetal status. The “Normal” output is in the range of 0–0.4; “Distress” output range is from 0.6 to 1.0, and the output range from 0.4 to 0.6 will be classified as “Indeterminate.”

The fuzzy rules can be written as:

Rule 1. If SI low and AMo low and LTV fast and STV fast, then there is normal fetal well-being.

IF SI↓ AND AMo↓ AND LTV↑ AND STV↑ THEN NORMAL.

Rule 2. If SI low and AMo low and LTV fast and STV slow, then there is unclear diagnosis.

IF SI↓ AND AMo↓ AND LTV↑ AND STV↓ THEN UNDETERMINATED.

Rule 3. If SI low and AMo low and LTV slow and STV fast, then there is unclear diagnosis.

IF SI↓ AND AMo↓ AND LTV↓ AND STV↑ THEN UNDETERMINATED.

Rule 4. If SI low and AMo low and LTV slow and STV slow, then there is unclear diagnosis.

IF SI↓ AND AMo↓ AND LTV↓ AND STV↓ THEN UNDETERMINATED.

Rule 5. If SI low and AMo high and LTV fast and STV fast, then there is unclear diagnosis.

IF SI↓ AND AMo↑ AND LTV↑ AND STV↑ THEN UNDETERMINATED.

Rule 6. If SI low and AMo high and LTV fast and STV slow, then there is fetal distress.

IF SI↓ AND AMo↑ AND LTV↑ AND STV↓ THEN DISTRESS.

Rule 7. If SI low and AMo high and LTV slow and STV fast, then there is fetal distress.

IF SI↓ AND AMo↑ AND LTV↓ AND STV↑ THEN DISTRESS.

Rule 8. If SI low and AMo high and LTV slow and STV slow, then there is fetal distress.

IF SI↓ AND AMo↑ AND LTV↓ AND STV↓ THEN DISTRESS.

Rule 9. If SI high and AMo low and LTV fast and STV fast, then there is unclear diagnosis.

IF SI↑ AND AMo↓ AND LTV↑ AND STV↑ THEN UNDETERMINATED.

Rule 10. If SI high and AMo low and LTV fast and STV slow, then there is fetal distress.

IF SI↑ AND AMo↓ AND LTV↑ AND STV↓ THEN DISTRESS.

Rule 11. If SI high and AMo low and LTV slow and STV fast, then there is fetal distress.

IF SI↑ AND AMo↓ AND LTV↓ AND STV↑ THEN DISTRESS.

Rule 12. If SI high and AMo low and LTV slow and STV slow, then there is fetal distress.

IF SI↑ AND AMo↓ AND LTV↓ AND STV↓ THEN DISTRESS.

Rule 13. If SI high and AMo high and LTV fast and STV fast, then there is unclear diagnosis.

IF SI↑ AND AMo↑ AND LTV↑ AND STV↑ THEN UNDETERMINATED.

Rule 14. If SI high and AMo high and LTV fast and STV slow, then there is fetal distress.

IF SI↑ AND AMo↑ AND LTV↑ AND STV↓ THEN DISTRESS.

Rule 15. If SI high and AMo high and LTV slow and STV fast, then there is fetal distress.

IF SI↑ AND AMo↑ AND LTV↓ AND STV↑ THEN DISTRESS.

Rule 16. If SI high and AMo high and LTV slow and STV slow, then there is loss of fetal well-being.

IF SI↑ AND AMo↑ AND LTV↓ AND STV↓ THEN FETAL DISTRESS.

4. Results

The results of the fuzzy diagnosis for 188 datasets are shown in **Figure 8**. Two well-defined clusters can be observed, corresponding to those who were clinically diagnosed as healthy pregnancies (+) and those who presented loss of fetal well-being (o). Can be observed that a

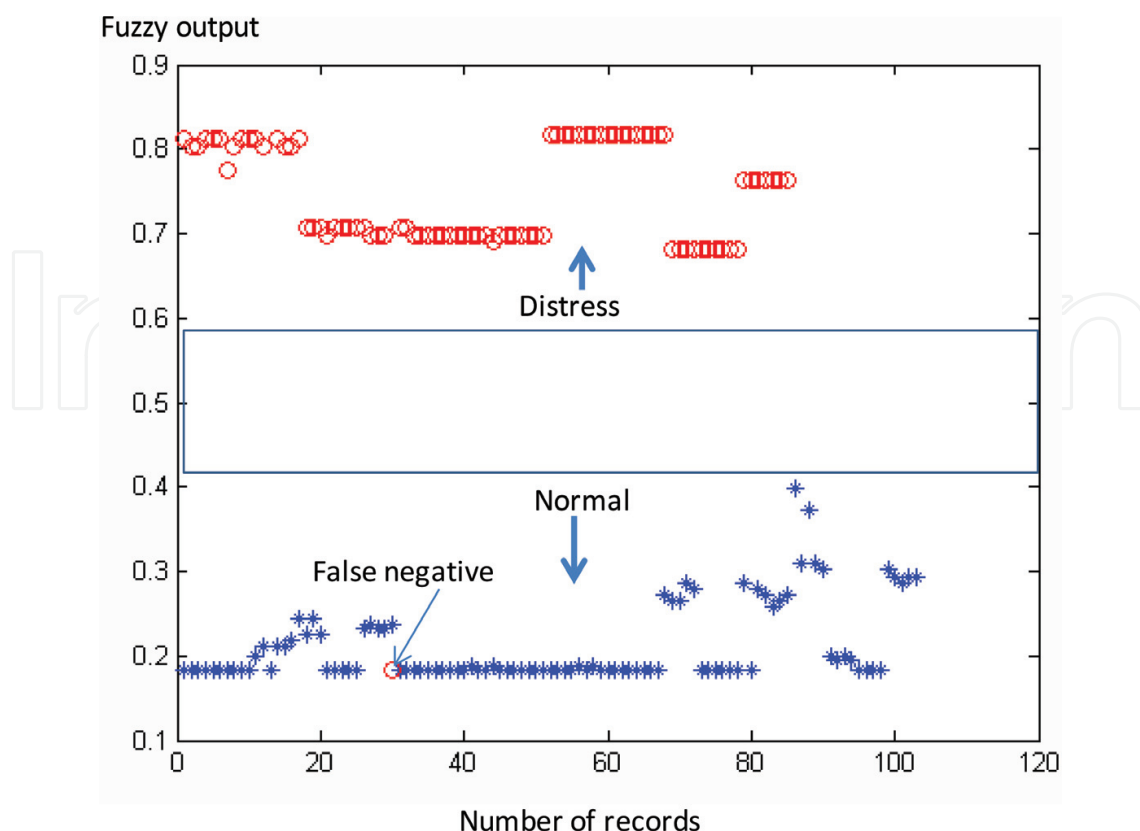

Figure 8. Scatter plot for fuzzy outputs of the 188 records.

fuzzy output from a high-risk pregnancy record with fetal distress was incorrectly evaluated by fuzzy system, fuzzy output of 0.183 classifies it as normal pregnancy.

Table 6 shows 6 of the 49 records, the values for their descriptors, the fuzzy output, and the clinical diagnosis. The records N16, N6, FGR6, FGR29, N27 are well evaluated by the fuzzy inference system, but the record FGR20, which corresponds to a fetal growth restricted pregnancy with fetal distress, is classified by fuzzy system as normal pregnancy. The ROC curve and confusion matrix for the 188 cases evaluated are shown in Figure 9.

Of the 188 records, 84 with fetal distress were correctly evaluated (true positives) and only one was diagnosed as normal (false negative). On the other hand, the 103 normal cases were

Record ID	SI	AMo	LTV	STV	Fuzzy output	Clinic DX
N16	1057	75	49.1	12	0.242	Normal
N6	3034	100	14.3	2.7	0.769	Fetal Distress
FGR6	687	77	49.2	9.5	0.247	Normal
FGR 29	2299	81	14.6	4.2	0.745	Fetal Distress
N27	2594	97	23.2	6.2	0.765	Fetal Distress
FGR 20	898	64	46.9	19.9	0.231	Fetal Distress

Table 6. SI, AMo, LTV, and STV values for fuzzy input descriptors, fuzzy assessment, and clinic diagnosis.

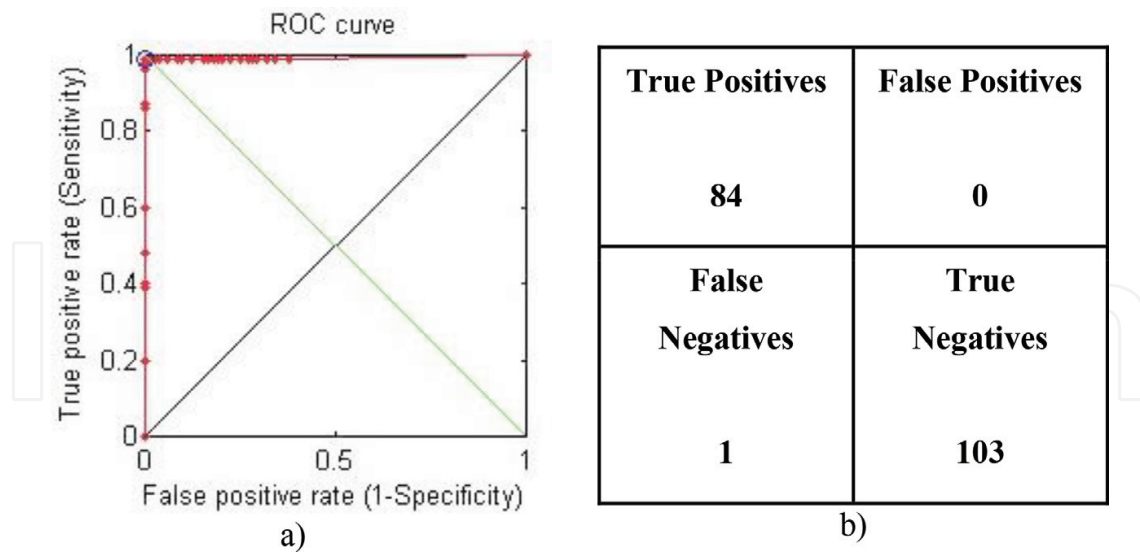

Figure 9. (a) ROC curve of the overall fuzzy system evaluation and (b) confusion matrix for 188 data evaluated.

diagnosed correctly (true negatives) by the fuzzy system. The global sensitivity was 0.9882 and global specificity was 1.

Finally, fuzzy inference system was evaluated with 21 new records of 30 minutes, classified as distress: D1-D3, and normal pregnancy: N1-N18. Each record was sampled at 2-minute interval. **Figure 10** shows the fuzzy evaluation of three records of patients with emergency

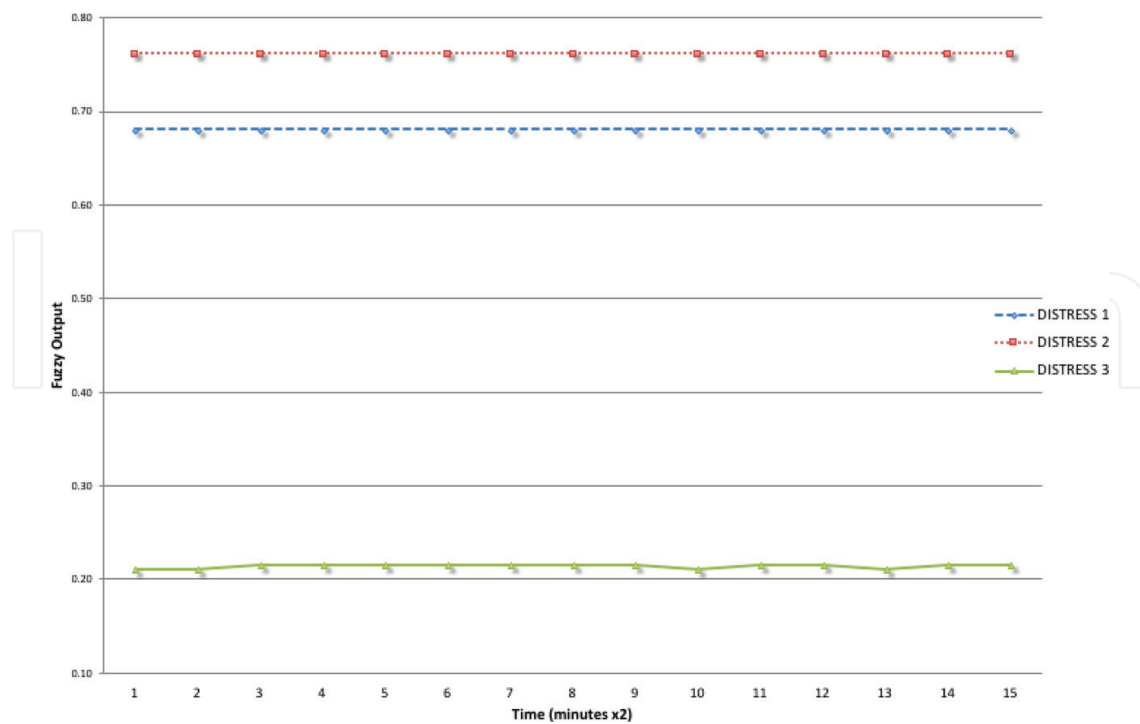

Figure 10. Fuzzy evaluation of three 30-minutes records of patients with emergency pregnancy.

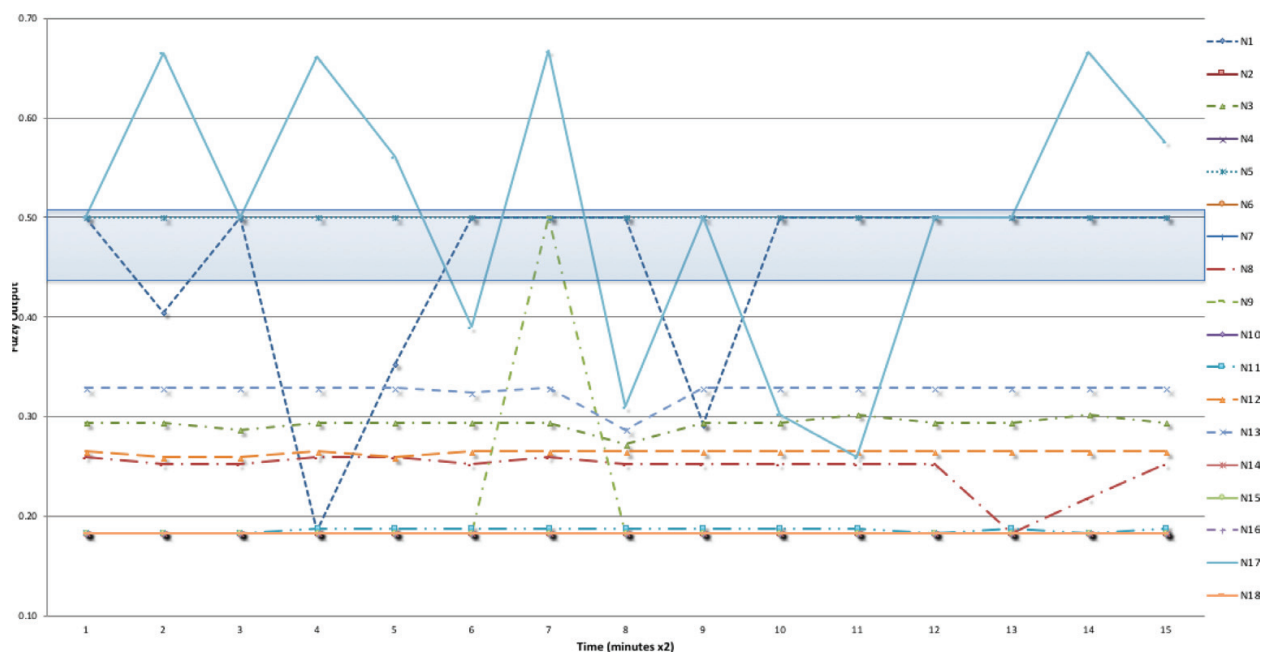

Figure 11. Fuzzy evaluation of eighteen 30-minute records of patients with normal pregnancy.

pregnancy. D1 and D2 were classified with fetal distress correctly, but D3 is shown with a normal fetal well-being state.

Figure 11 shows the fuzzy inference of 18 patients with normal pregnancy. Records N2-N4, N6-N16, and N18 show a normal fetal well-being during the 30-minute recording. The record N1 shows an indeterminate state, except for periods of 3–5 and 8–10 minutes, where the assessment of fetal well-being is normal. The record N5 was classified by the fuzzy system as indeterminate. N17 shows fetal distress from minutes 3 to 9, between minutes 15 and 21 the fetal state changes to normal, returning to distress after minute 27.

5. Conclusions

A combination of fetal HRV and CTG descriptors was proposed for discrimination between fetuses with loss of fetal well-being and normal fetuses, both in pregnancies with intrauterine growth restriction and healthy pregnancies.

The feasibility of the selected descriptors, SI, AMo, STV, and LTV was evaluated by sensitivity, specificity, and Spearman's correlation analysis, so that these parameters can be considered as evident markers of fetal well-being status in the case of FGR.

Since SI and AMo are relevant to the sympathetic part of the autonomic regulation, the opinion on the involvement of the sympathetic mechanisms in fetal distress is supported [1]. The predictive value of the parasympathetic regulation variables was lower. The growing activity of this division of the autonomic function is a marker of fetal neurological maturation [5]. The relation found between maternal and fetal HRV parameters was a sign of fetal and maternal

coupling in healthy pregnancy. Maternal respiratory sinus arrhythmia was speculated as a reason of this regularity. It was disturbed in preeclampsia [11]. Fetal growth is known to be impacted by maternal organism [6, 13]. The investigation of the possible relations between maternal and fetal HRV and its fractal components will create a novel concept of the management of women with growth-restricted fetuses.

Formerly, the most sensitive and specific for fetal distress T/QRS ratio obtained from fetal noninvasive ECG tracing was found [1, 12]. Since peaks and intervals are detectable on fetal-averaged PQRST complex, the subsequent investigation of their clinical significance is of great prospect. But the study population of the abovementioned research was suffered from preeclampsia. Thus, preeclampsia could change fetal cardiac conductivity. But will T/QRS ratio be of use in diagnosing fetal distress among all pregnant women is still a question?

The main criterion of fetal well-being is a reactivity to its motile activity by accelerating the heart rate during nonstress test [2, 3]. The obtained results could make it possible to think that SI and AMo will become an alternative to the Dawes-Redman criteria. The assessment of short-term variations (STV) and long-term variations (LTV) was found to be of use in diagnosing fetal compromise. These variables used in CTG monitors are known as the most evident markers of fetal distress [4, 9]. But the duration of the recording should be not less than 1 hour or, at least, 30 minutes. This time interval is known to be associated with better sleep/awake fetal status ratio [2, 4]. Therefore, the application of the proposed fetal HRV variables will help to use fetal noninvasive ECG tracing of the only 10 minutes long. It will be more convenient in clinical practice. Another advantage is the possibility to support or neglect fetal distress in case of negative (areactive) or false-negative nonstress test.

The hypothesis of the intrauterine programming of the diseases determines that any abnormalities during fetal life will have a subsequent clinical manifestation afterward. The cardiac signals proceeding is a convenient approach to the assessment of fetal autonomic maturation [6, 13]. Fetal HRV variables are disturbed in growth-restricted fetuses. Therefore, the investigation of fetal neurobehavioral response in case of intrauterine growth restriction is a possible way for the fetal well-being screening. But fetal growth restriction is not always associated with fetal distress and still stimulating obstetrical aggression in its projections on the term and the mode of delivery. That is why the outcome of our research in future is an advanced protocol of management of pregnant women with fetal growth restriction.

The findings of this work are based on fetal noninvasive ECG investigation. This method is still a challenge for the clinician [9]. The main problem is a low signal-to-noise ratio [1]. But fetal noninvasive ECG could be used for fetal Holter monitoring. The possibility for the creation of the system for fetal wireless distant monitoring will contribute to the better diagnosing of fetal compromise and cardiac arrhythmias.

HRV and CTG proposed descriptors can be used in an assessment system, for discrimination or prediction between fetuses with loss of fetal well-being and normal fetuses, both in pregnancies with intrauterine growth restriction and pregnancies of healthy fetuses.

Finally, a system based on fuzzy logic was designed with these descriptors in order to obtain an evaluation of the fetal well-being status. Only one false negative was obtained in the

diagnosis using 188 data, which represents an accuracy of 98.8% in fetal distress prediction, and 100% in healthy pregnancy.

Author details

Igor V. Lakhno¹, Bertha Patricia Guzmán-Velázquez^{1,2*} and José Alejandro Díaz-Méndez^{1,2}

*Address all correspondence to: pguzman@inaoep.mx

1 Obstetrics and Gynecology Department of Kharkiv Medical Academy of Postgraduate Education, Kharkiv, Ukraine

2 Electronics Department of National Institute of Astrophysics, Optics and Electronics, Puebla, México

References

- [1] Lakhno I. The Use of Fetal Noninvasive Electrocardiography. Hindawi: Scientifica; 2016: 1-6. <https://doi.org/10.1155/2016/5386595>
- [2] Visser et al. Cardiotocography alone is outdated and ST analysis is the way forward in fetal monitoring: FOR: Does the use of ST analysis in conjunction with cardiotocography improve perinatal outcome and/or reduce interventions for fetal distress? BJOG: An International Journal of Obstetrics and Gynaecology. 2016;**123**:1636
- [3] Gupta M, Gupta P. Role of cardiotocography in high risk pregnancy and its correlation with increase cesarean section rate. International Journal of Reproduction, Contraception, Obstetrics and Gynecology. 2016;**6**(1):168-171
- [4] Clark SL et al. The limits of electronic fetal heart rate monitoring in the prevention of neonatal metabolic acidemia. American Journal of Obstetrics and Gynecology. 2017;**216**(2): 163.e1-163.e6
- [5] Ortiz MR, Echeverría JC, Álvarez-Ramírez J, Martínez A, Peña MA, García MT, et al. Effects of fetal respiratory movements on the short-term fractal properties of heart rate variability. Medical & Biological Engineering & Computing. 2013;**51**(4):441-448
- [6] Aziz W, Schlindwein FS, Wailoo M, Biala T, Rocha FC. Heart rate variability analysis of normal and growth restricted children. Clinical Autonomic Research. 2012;**22**(2):91-97
- [7] Schobel HP, Fischer T, Heuszer K, Geiger H, Schmieder RE. Preeclampsia—A state of sympathetic overactivity. New England Journal of Medicine. 1996;**335**(20):1480-1485
- [8] Rosser ML, Katz NT. Preeclampsia: An obstetrician's perspective. Advances in Chronic Kidney Disease. 2013;**20**(3):287-296

- [9] Reinhard J, Hayes-Gill BR, Yi Q, Hatzmann H, Schiermeier S. Comparison of non-invasive fetal electrocardiogram to Doppler cardiocogram during the 1st stage of labor. *Journal of Perinatal Medicine*. 2010;**38**(2):179-185
- [10] Oudijk MA, Kwee A, Visser GH, Blad S, Meijboom EJ, Rosén KG. The effects of intrapartum hypoxia on the fetal QT interval. *BJOG: An International Journal of Obstetrics & Gynaecology*. 2004;**111**(7):656-660
- [11] Lakhno I. Autonomic imbalance captures maternal and fetal circulatory response to pre-eclampsia. *Clinical Hypertension*. 2017;**23**(1):5
- [12] Lakhno I. Fetal non-invasive electrocardiography contributes to better diagnostics of fetal distress: A cross-sectional study among patients with pre-eclampsia. *Annals of the Academy of Medicine, Singapore*. 2015;**44**(11):519-523.15
- [13] Ferrario M, Signorini MG, Magenes G. Complexity analysis of the fetal heart rate variability: Early identification of severe intrauterine growth-restricted fetuses. *Medical & Biological Engineering & Computing*. 2009;**47**(9):911-919
- [14] Lakhno IV. The hemodynamic repercussions of the autonomic modulations in growth-restricted fetuses. *Alexandria Journal of Medicine*. 2017;**53**(4):333-336
- [15] Lakhno I. The relationship between fetal and maternal hemodynamic oscillations in normal and growth restricted fetuses. *Athens Journal of Health*. March 2017;**4**(1):51-59
- [16] Lakhno IV. A novel trophotropic mechanism of fetal wellbeing. *New Armenian Medical Journal*. 2014;**8**(1):68-72
- [17] Liu C, Li P. Systematic methods for fetal electrocardiographic analysis: Determining the fetal heart rate, RR interval and QT interval. In: *Computing in Cardiology Conference (CinC)*. IEEE; 2013. pp. 309-312
- [18] Fuentealba P, Illanes A, Ortmeier F. Progressive fetal distress estimation by characterization of fetal heart rate decelerations response based on signal variability in cardiocographic recordings. *Computing*. 2017;**44**:1
- [19] Warmerdam GJ, Vullings R, Van Laar JO, Bergmans JWM, Schmitt L, Oei SG. Selective heart rate variability analysis to account for uterine activity during labor and improve classification of fetal distress. In: *Engineering in Medicine and Biology Society (EMBC), 2016 IEEE 38th Annual International Conference of the IEEE*. USA; 2016 August. pp. 2950-2953
- [20] Fanelli A, Magenes G, Campanile M, Signorini MG. Quantitative assessment of fetal wellbeing through CTG recordings: A new parameter based on phase-rectified signal average. *IEEE Journal of Biomedical and Health Informatics*. 2013;**17**(5):959-966

